

Part Number: PT296-00170
PT296-12170
(Extension Module w/ AHA)

Kit Contents

Item #	Quantity Req'd.	Description
1	1	Extension Module
2	1	BT cable
3	1	DA/Ext Harness
4	1	GPS Antenna kit
5	6	Bolt (M5x8)
6	5	Wire tie (10")

Hardware Bag Contents

Item #	Quantity Req'd.	Description
1	1	GPS Antenna
2	1	GPS Plate w/ Adhesive
3	5	Wire tie (6")
4	1	Foam pad w/ Adhesive

Additional Items Required For Installation

Item #	Quantity Req'd.	Description
1	1	Clamp bracket P/N: PT228-18160

Conflicts

None

Recommended Tools

Personal & Vehicle Protection	Notes
Blankets	
Special Tools	Notes
USB Flash Drive Media	Must contain MP3 songs
AUX Tester	
Installation Tools	Notes
Panel Clip Removal Tool	e.g. Toyota SST P/N: 00002-06002-01
Ratchet	
Socket	8mm, 10mm
Socket Extension	6"
Screwdriver	Phillips, #2
Screwdriver	Phillips, Stubby
Torque Wrench	5.4N·m (48 lbf·in)
Scissors	
Masking tape	
Electrical Tape	
Diagonal Cutters	
Special Chemicals	Notes
Cleaner	VDC Approved

General Applicability

All 86 models

Recommended Sequence of Application







Item #	Accessory
1	Navigation Upgrade (Extension Module)
2	Base Audio
3	

*Mandatory

Vehicle Service Parts (may be required for reassembly)

Item #	Quantity Req'd.	Description
1		
2		
3		

Legend

	STOP: Damage to the vehicle may occur. Do not proceed until process has been complied with.
	OPERATOR SAFETY: Use caution to avoid risk of injury.
	CAUTION: A process that must be carefully observed in order to reduce the risk of damage to the accessory/vehicle and to ensure a quality installation.
	TOOLS & EQUIPMENT: Used in Figures calls out the specific tools and equipment recommended for this process.
	REVISION MARK: This mark highlights a change in installation with respect to previous issue.
	SAFETY TORQUE: This mark indicates that torque is related to safety.

Parts Description of Extension Module Kit (PT296-00170 or PT296-12170)

Item #	Part Name	Part No.	Qty
1	Extension Module	PT296-00170-AA or PT296-12170-AA	1
2	Harness	86842-12010	1
3	Bolt (M5 x 8)	90153-W0001	6
4	BT cable	86705-02070	1
5	GPS Antenna	PZ490-00338-00	1
6	Wire Tie (10")		5
7	Wire Tie (6")		5
8	GPS Plate w/ Adhesive back		1
9	Foam Adhesive Pad (25cm x 8cm)		1

Not included in kit but REQUIRED for installation: Clamp Brackets (PT228-18160)

Item #	Part Name	Part No.	Qty
1	Clamp Brackets	PT228-18160	1

Care must be taken when installing this accessory to ensure damage does not occur to the vehicle. The installation of this accessory should follow approved guidelines to ensure a quality installation.

These guidelines can be found in the "Accessory Installation Practices" document.

This document covers such items as:-

- Vehicle Protection (use of covers and blankets, cleaning chemicals, etc.).
- Safety (eye protection, rechecking torque procedure, etc.).
- Vehicle Disassembly/Reassembly (panel removal, part storage, etc.).
- Electrical Component Disassembly/Reassembly (battery disconnection, connector removal, etc.).

Please see your Toyota dealer for a copy of this document.

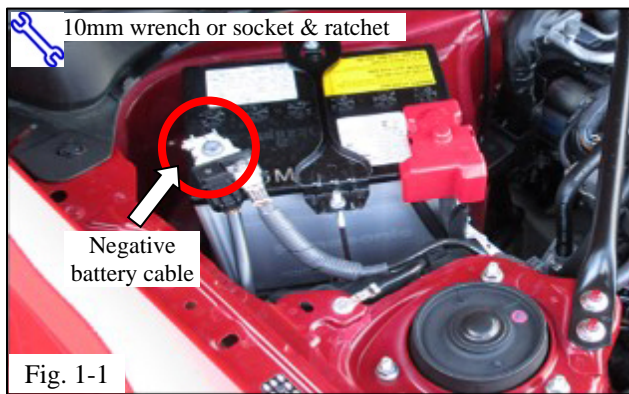

1. Protect the Vehicle.

- (a) Protect the fender before starting.
- (b) Remove the negative battery cable (Fig. 1-1).
- CAUTION:** Do not touch the positive terminal with any tool when removing cable.
- (c) Check the kit contents.
- (d) Cover the steering wheel with a blanket to prevent scratches.

2. Disassemble the Vehicle.

- NOTE:** Place all removed parts on a protected surface.
- NOTE:** When disconnecting wiring connectors DO NOT pull on the wiring, pull on the connector only.
- NOTE:** Engage the parking brake while working.
- (a) Use protective tape to protect the trim panel (Fig. 2-1).
- (b) Pull the cluster forward and disengage the clips at 5 locations with the pry tool (Fig. 2-1).

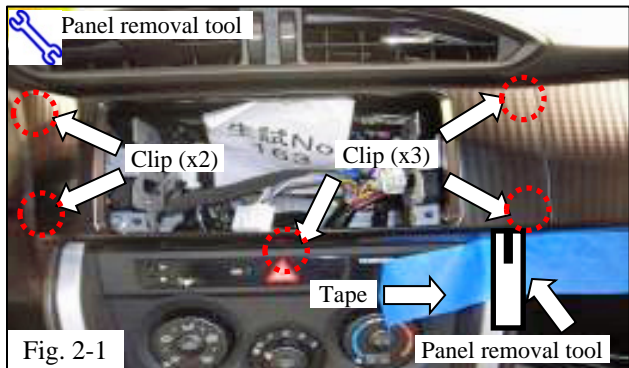

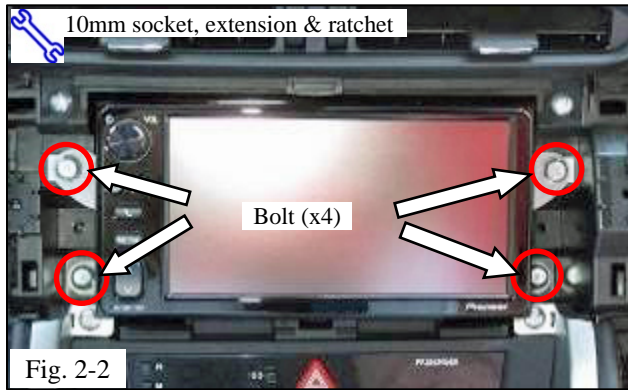

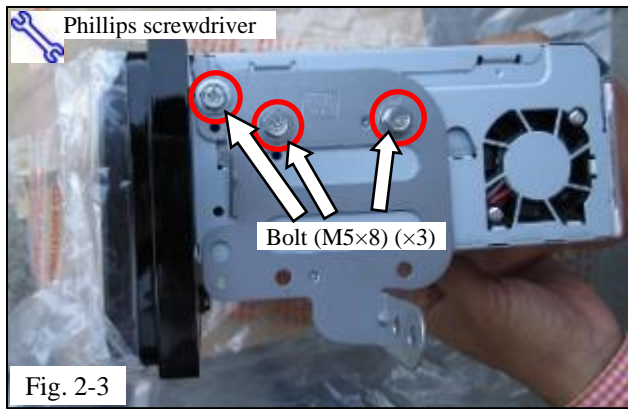

(c) Remove the 4 bolts, disconnect all electrical connections from the back of the base display radio and then remove the radio (Fig. 2-2). Save the bolts for reuse.

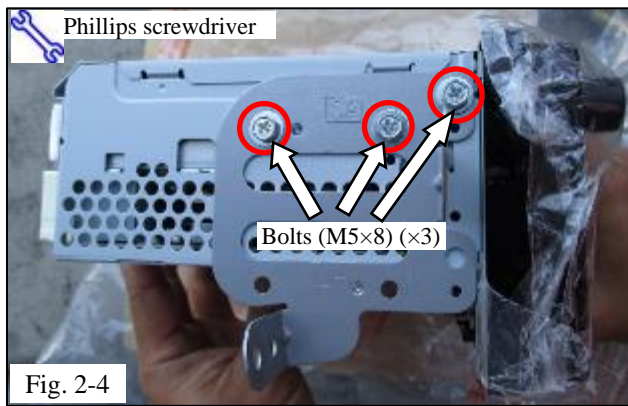

(d) Remove the RH and LH brackets from the audio unit.
(1) Remove the three (3) bolts from the RH bracket and remove the RH bracket (Fig. 2-3).



(2) Remove the three (3) bolts from the LH bracket and remove the LH bracket (Fig. 2-4).

 (3) Save the brackets and bolts.

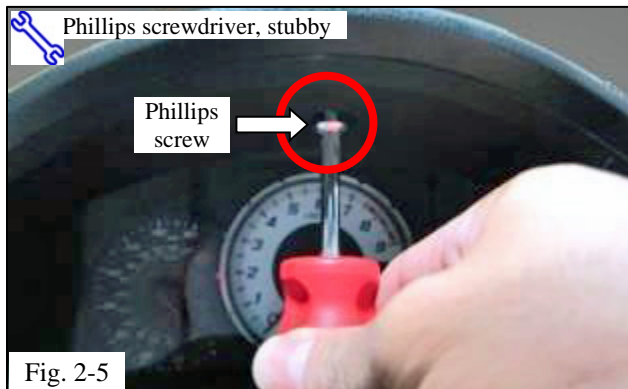

(e) Remove the top instrument cluster cover.
(1) Use a Phillips screwdriver to remove the screw which fastens the bezel above the instrument panel (Fig. 2-5).

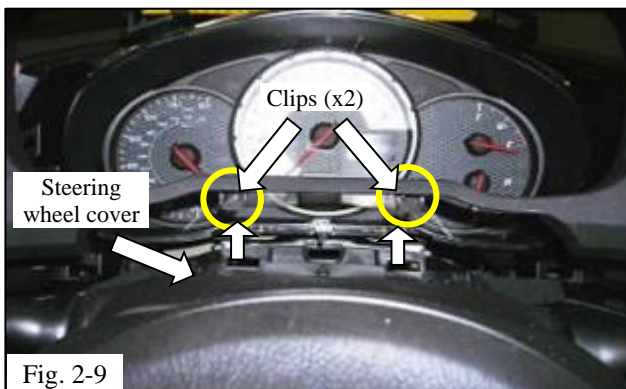
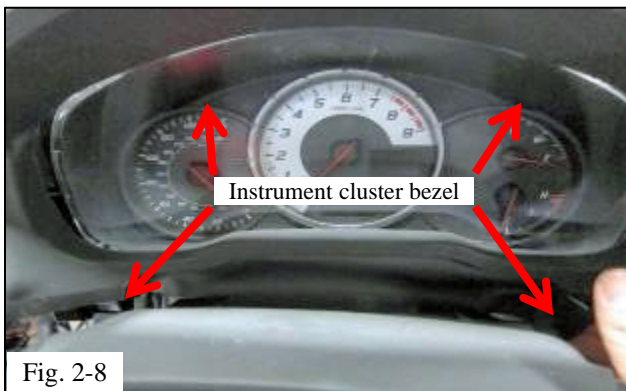
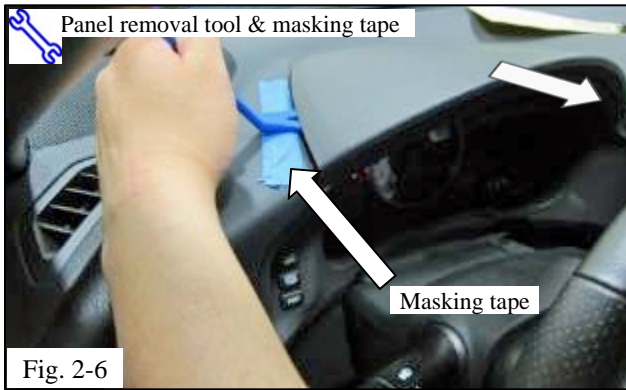

- (2) Place masking tape to the left edge of the instrument cluster top bezel to prevent damage to dash trim pieces (Fig. 2-6).
- (3) Gently insert a panel removal tool between the trim pieces and pry upward (Fig. 2-6).
- (4) Insert fingers under the cover edge that was lifted and work the hand around clockwise to unsecure the top trim piece.
- (5) Remove the top instrument cluster cover and set in a safe place (Fig. 2-7).

(f) Remove the instrument cluster bezel.

- (1) Pull the instrument cluster bezel out so that it is loose from the instrument cluster (Fig. 2-8).
- (2) Separate the 2 clips between the instrument cluster bezel and the upper steering wheel cover to remove the instrument cluster bezel (Fig. 2-9).

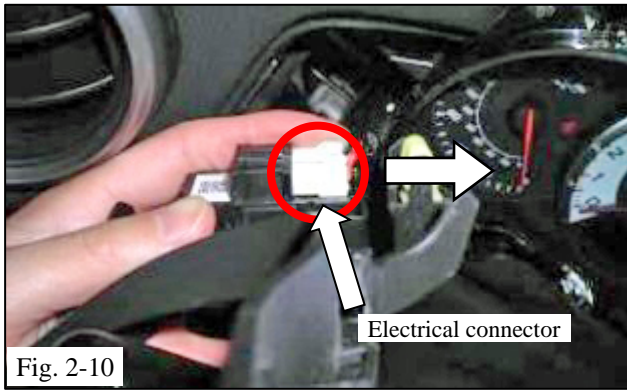

- (3) Tilt the top of the bezel forward, reach behind the bezel and disconnect the electrical connector from the bezel (Fig. 2-10).

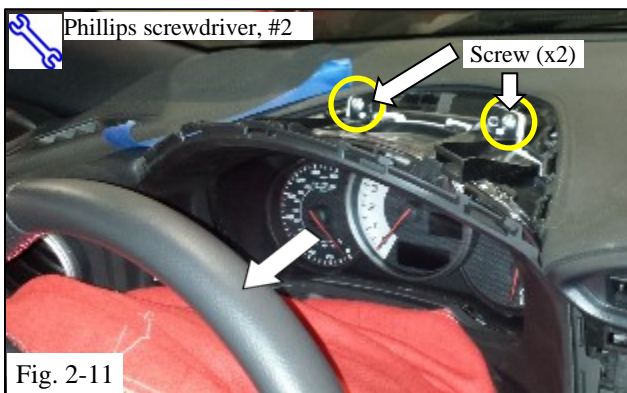

- (g) Remove instrument cluster.
 - (1) Use a Phillips head screwdriver to remove the 2 screws securing the instrument cluster in place (Fig. 2-11).



- (2) Pull the instrument cluster forward and disconnect the electrical connector (Fig. 2-12).
 - (3) Remove the instrument cluster.

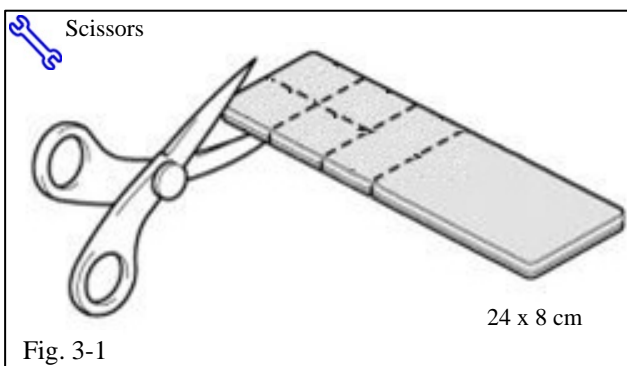

3. Install the GPS Antenna.

- (a) Cut the foam tape (Fig. 3-1).
 - (1) Cut four small pieces (4x4cm)
 - (2) Cut one large piece (4x8cm)
 - (3) Not all of the material will be used.
- ⚠ (b) Clean the GPS antenna mounting surface with VDC approved cleaner.



(c) Remove the GPS plate (Fig. 3-2) from the parts bag kit.



(d) Remove the paper off of the back of the GPS plate to expose the adhesive (Fig. 3-3).



(e) With the adhesive side facing downward, secure the GPS plate onto the mounting surface (Fig. 3-4 & Fig. 3-5).



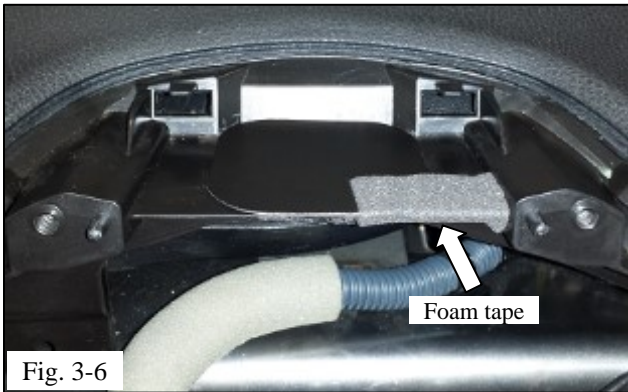

- (f) Apply a small piece (4x4cm) of foam tape along the right edge of the trim (Fig. 3-6).



- (g) Place the GPS antenna onto the center of the GPS plate with the harness facing to the right (Fig. 3-7).

⚠ NOTE: Ensure the GPS antenna is centered on the GPS plate (Fig. 3-7).

- (h) Route the GPS antenna wire to the right of the GPS plate and down over the foam tape.

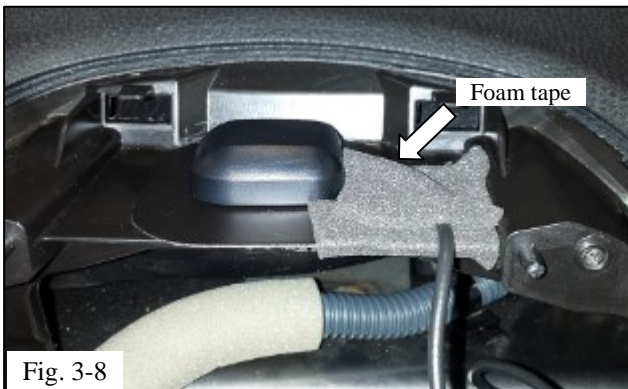

- (i) Apply another small piece of foam tape (4x4cm) to secure the placement of the GPS antenna wire (Fig. 3-8).

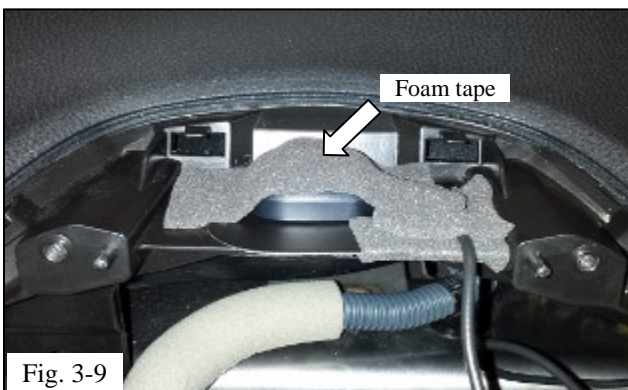

- (j) Place a large piece of foam tape (4x8cm) over the GPS antenna to keep the antenna in place (Fig. 3-9).

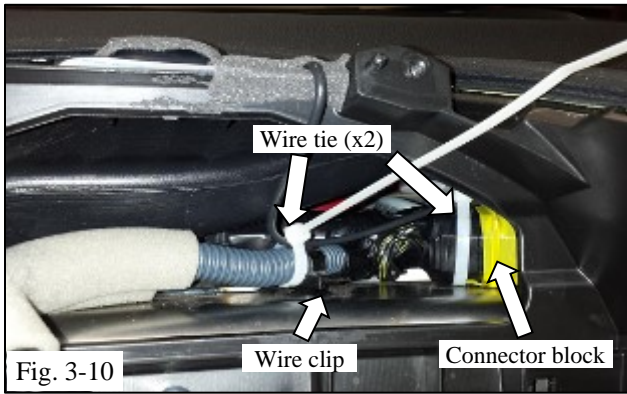

(k) Route the GPS wire down to the vehicle wire harness and secure it to the vehicle harness near the wire harness clip with a 10" wire tie (Fig. 3-10).

(l) Continue to route the harness to the right along the vehicle harness and secure it to the connector block with a 10" wire tie (Fig. 3-10).

⚠ NOTE: Keep the GPS wire above the vehicle harness.

(m) Continue to route the GPS antenna wire along the vehicle harness to the right toward the audio opening area (Fig. 3-11).

⚠ NOTE: Keep the GPS wire above the vehicle harness.

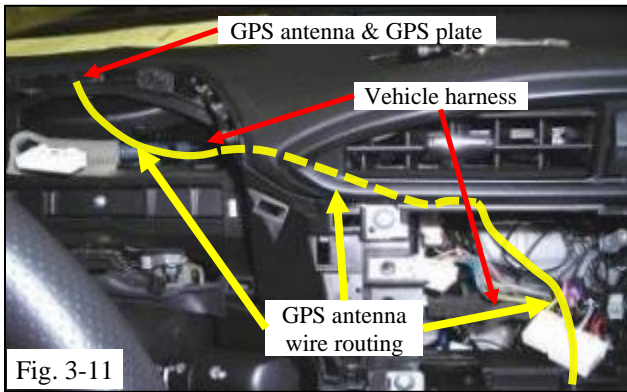

(n) Secure the GPS wire to the vehicle harness with a 10" wire tie (Fig. 3-12).

(1) The wire tie should be located just to the right of the metal plate.

(2) Keep the GPS wire above the vehicle harness.

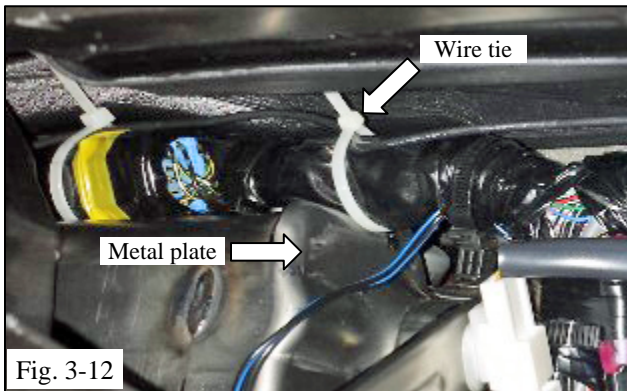



- (o) Secure the GPS wire to the vehicle harness in the audio opening area with a 10" wire tie (Fig. 3-13).

⚠ NOTE: Keep the GPS wire above the vehicle harness.

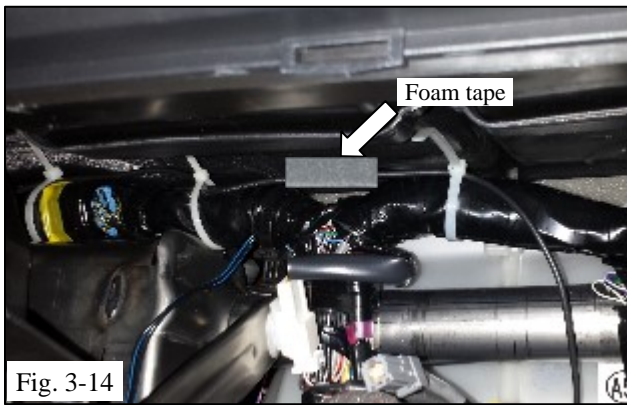

- (p) Secure the GPS wire between the two wire ties to the bottom of the air duct using one small piece of foam tape (4x4cm) (Fig. 3-14).



- (q) Route the GPS wire along the USB cable and line up the GPS wire connector with the USB connector (Fig. 3-15).

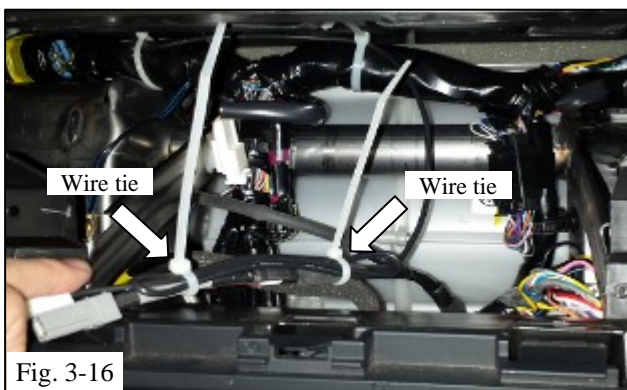

- (r) Bundle any excess wire and secure the GPS wire bundle to the USB cable with two 6" wire ties (Fig. 3-16).
- (s) Trim all wire ties.

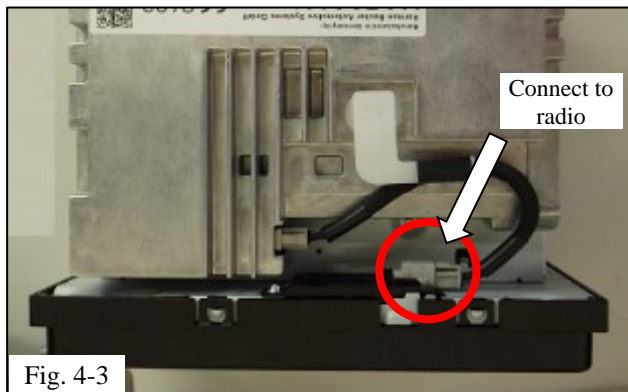
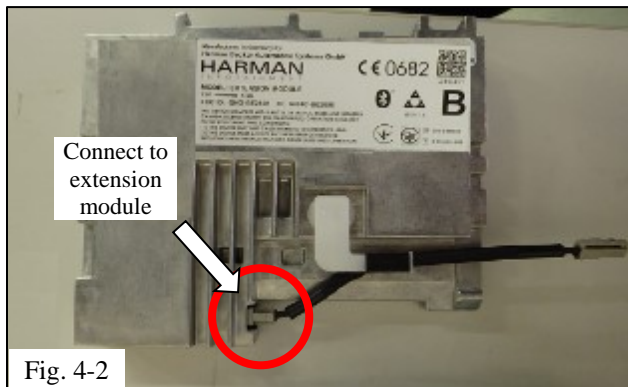
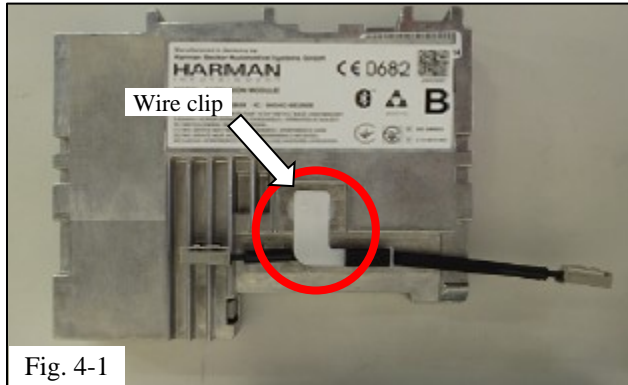

4. Assemble the Radio and Extension Module.

(a) Lay the extension module on a flat surface with the large label side facing upwards (Fig. 4-1).

(b) Insert the wire clip that is attached to the Bluetooth antenna wire into the extension module (Fig. 4-1).

(c) Plug the Bluetooth antenna connector into the extension module (Fig. 4-2).

(d) Lay the radio on a flat surface with the bottom facing upward.

(e) Place the extension module on the bottom of the radio (Fig. 4-3).

(f) Plug the Bluetooth antenna connector into the radio (Fig. 4-3).

⚠ NOTE: Make sure both ends of the harness are securely seated between the extension module and the radio.



Fig. 4-4

(g) Install the LH and RH clamp brackets to the audio unit and extension box (Fig. 4-4).

⚠ NOTE: Make sure the holes line up to the radio and the extension module.

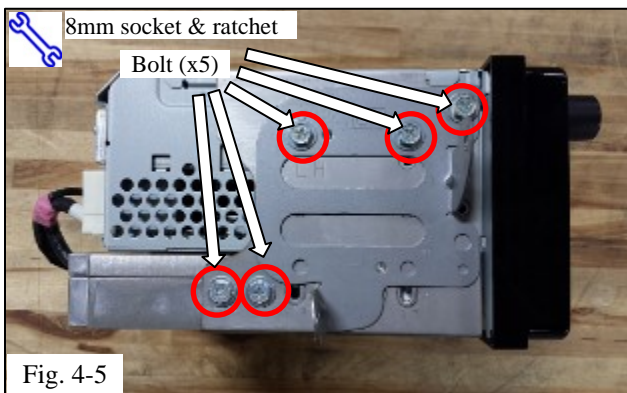

Fig. 4-5

(h) Fasten the LH mounting bracket to the radio using three bolts from the audio kit (Fig. 4-5).

(i) Fasten the LH mounting bracket to the extension module with two bolts from the extension module kit (Fig. 4-5).

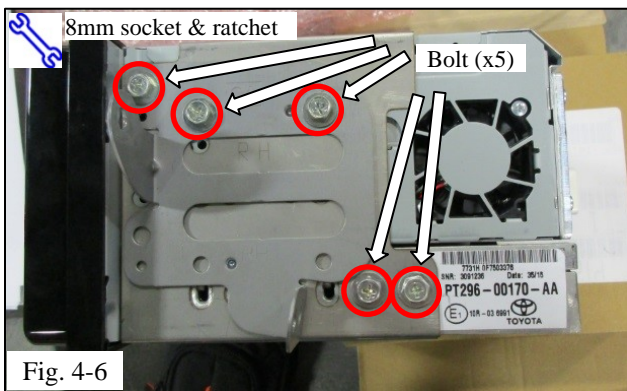
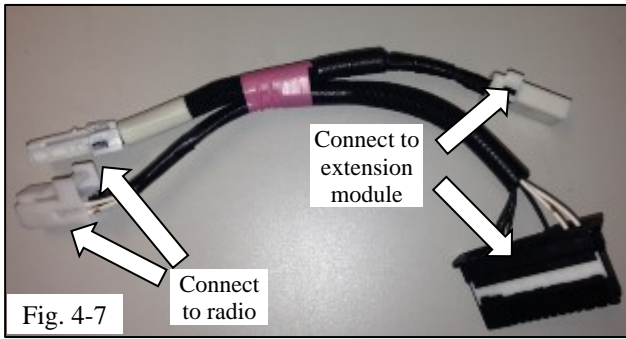

Fig. 4-6

(j) Fasten the RH mounting bracket to the radio using three bolts from the audio kit (Fig. 4-6).

(k) Fasten the RH mounting bracket to the extension module with two bolts from the extension module kit (Fig. 4-6).



- (1) Connect the extension module interface wire harness between the extension module and the radio (Fig. 4-7 & Fig. 4-8).



5. Install the Premium Audio Assembly (Wire Harness Connections).



-  (a) Place a blanket around the instrument panel opening to prevent scratches (Fig. 5-1).

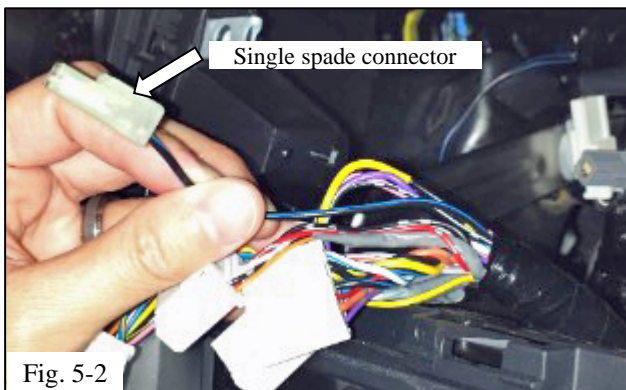

- (b) Locate the single spade connector with the black wire with blue stripe (Fig. 5-2).

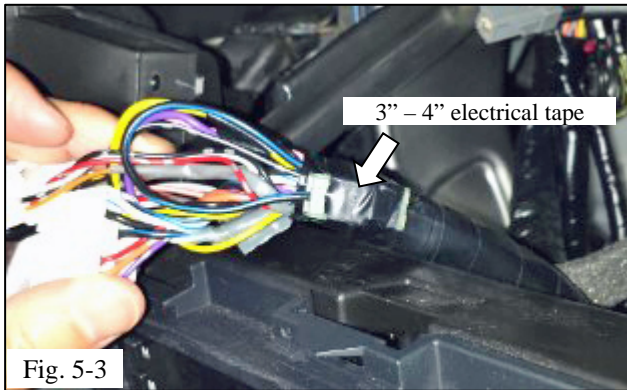

(c) Bend the wire back and secure the connector to the audio harness with a 3"- 4" piece of electrical tape (Fig. 5-3).

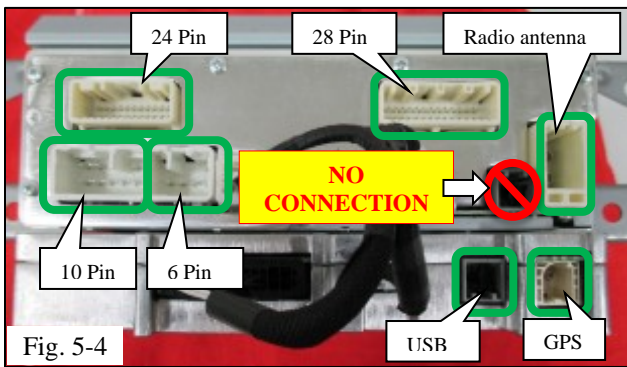

(d) Connect the radio antenna cable, 28 pin, 24 pin, 6 pin, and 10 pin harness connector cables to the base display radio (Fig. 5-4 & Fig. 5-5).

(e) Connect the USB cable and GPS antenna cable to the extension module (Fig. 5-4 & Fig. 5-5).



Do not connect the USB cable to the Base Display Radio. The USB cable must be connected to the extension module. (Fig. 5-5)

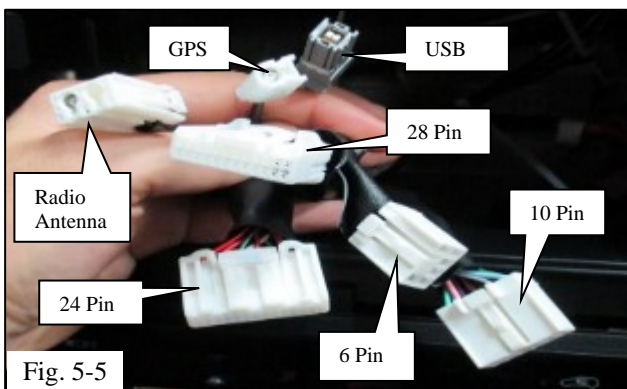

(f) Confirm all harness connections are completed (Fig. 5-6).



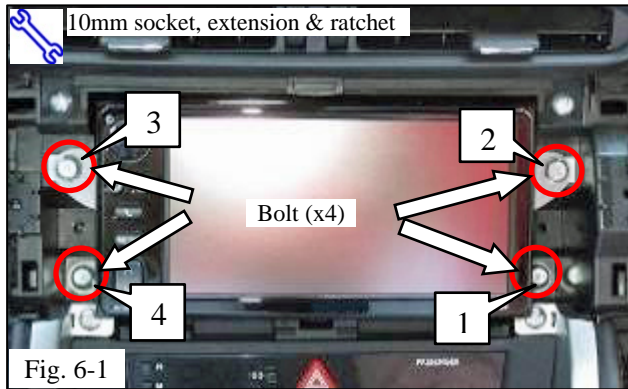

6. Install the Premium Audio Assembly (Mount in the Vehicle).

- (a) Install the Premium Audio assembly into the instrument panel (Fig. 6-1).
- (b) In the sequence shown (1 to 4), insert and hand start each bolt (Fig. 6-1).

⚠ NOTE: The bolts can easily become stripped if they are started with a drill or driver tool.

- (c) Tighten all bolts in the same sequence (Fig. 6-1).
- (d) Temporarily connect the negative battery cable.

⚠ CAUTION: Do not touch the positive terminal with any tool when attaching the cable.

7. Confirm that the Extension Module is Connected.

- (a) Turn the vehicle ignition switch to the ACC position.
- (b) After the warning screen, press the “MEDIA” button.

⚠ NOTE: Each time the “MEDIA” button is pressed the system will switch the screen between MAP and the last audio mode used (Fig. 7-1).

- (c) Confirm if the Map screen is shown (Fig. 7-1).





8. Check the USB Connection.

- (a) With the ignition switch still the in ACC position, connect the USB flash drive media to the vehicle's USB jack (Fig. 8-1).
- (b) Press the "MEDIA" source button to see the map split view screen. The audio source split view should show the USB audio playback (Fig. 8-2).
- (c) Confirm that the USB source can be selected.
- (d) Confirm that a song plays.
- (e) Remove the flash drive from the USB jack.
- (f) Press the "MEDIA" button.
- (g) Press the source button to go to the audio screen.
- (h) Plug in the AUX tester.
- (i) Confirm that the AUX source can be selected.
- (j) Remove the AUX tester.

⚠ NOTE: Each time the "MEDIA" button is pressed the system will switch the screen between MAP and the last audio mode used (Fig 7-1).

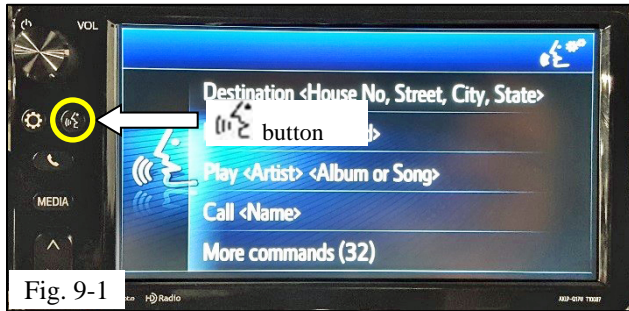



Fig. 9-1



Fig. 9-2

9. Check the Microphone and Vehicle Antenna.

- (a) With the ignition switch still the in ACC position, press the  button (Fig. 9-1).
- (b) After the beep say, “Tune to 99.7.”
- (c) Wait until the voice recognition session is complete. The screen should switch to FM mode showing FM 99.7.

- (d) Press the SEEK/TRACK “up” button (Fig. 9-2).
- (e) Confirm that the radio tunes to an FM radio station and sound is heard.

10. Complete the Installation.

- (a) Complete the reassembly of the vehicle.
 - (1) Reconnect any disconnected connectors.
 - (2) Verify the panels fit together properly with no uneven gaps.

- (b) Clean up and remove any trash.

- (c) Reconnect the vehicle’s negative battery cable (Fig. 11-1).
 - (1) Position the negative cable at the original factory position.

+ **CAUTION:** Do not touch the positive terminal with any tool when replacing the cable.

- (2) Tighten the nut to 5.4 N•m (48 lbf•in).

S **Torque: 5.4 N•m. (48 lbf•in)**

- (d) Perform the functional checks.

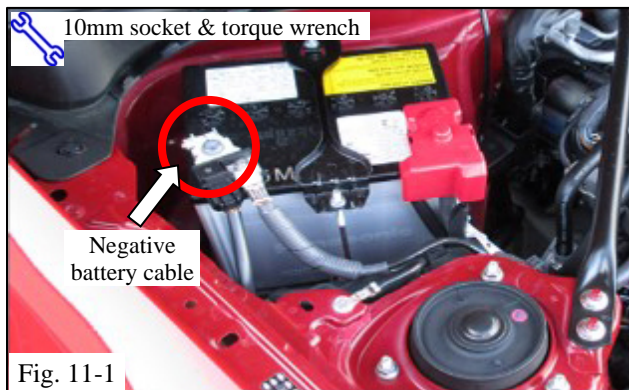
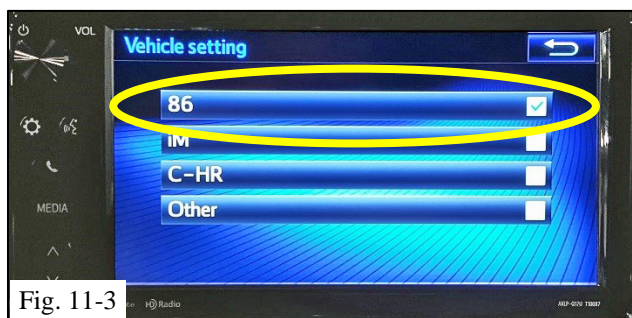



Fig. 11-1



(e) With the ignition switch in the ACC or ON position, set the vehicle specific audio configuration.

(1) Press the  button (Fig. 11-2).

(2) Select the “Vehicle” tile in the Setup menu.

(3) Select “86” from the “Vehicle setting” list (Fig. 11-3).

(f) If required, replace the 30A DCC fuse to its original position.

Checklist - these points **MUST** be checked to ensure a quality installation.

<u>Check:</u>	<u>Look For:</u>
<p><u>Accessory Function Checks</u></p> <ul style="list-style-type: none"> <input type="checkbox"/> Turn on radio <input type="checkbox"/> Antenna <input type="checkbox"/> Fader <input type="checkbox"/> Balance <input type="checkbox"/> Illumination 	<ul style="list-style-type: none"> Radio functions properly Reception of AM/FM stations Functioning shift from front/rear speakers Functioning shift from left/right speakers Lights function properly
<p><u>Vehicle Function Checks</u></p> <ul style="list-style-type: none"> <input type="checkbox"/> Combination meter <input type="checkbox"/> kph/mpg unit switch <input type="checkbox"/> ODO trip button <input type="checkbox"/> DISP button <input type="checkbox"/> Rheostat/Dimmer <input type="checkbox"/> Steering wheel audio controls 	<ul style="list-style-type: none"> Meter functions properly Cycles kph/mpg units Cycles odometer Cycles display Lights dim/brighten properly Controls function properly
<p><u>Vehicle Appearance Check</u></p> <ul style="list-style-type: none"> <input type="checkbox"/> After accessory installation and removal of protective cover(s), perform a visual inspection. 	<p>Ensure no damage (including scuffs and scratches) was caused during the installation process. (For PPO installations, refer to TMS Accessory Quality Shipping Standard.)</p>